



## Pressure transmitter with CANopen interface

- Ceramic thick film or metallic thin film strain gauge measuring principles
- Process connections: G, NPT in 1/4" or G 3/4" (with hygienic flush diaphragm) or clamp 1 1/2"
- Linearised and temperature compensated measuring ranges from -1...5 bar or 0...0.25 bar up to 0...16 bar selectable, relative pressure
- Medium temperature range dependent on measurement principle: -20...+85 °C (ceramic), -40...+125 °C (metallic)
- Access to measurement value, device status and settings via CANopen interface

Product variants described in the data sheet may differ from the product presentation and description.

### Can be combined with



**Type ME43**  
Fieldbus gateway ▶



**PLC**  
With CANopen interface

Integration into CANopen and bus networks

### Type description

The product is used for measuring either relative or absolute pressures (on request) in liquid and gaseous media.

Two techniques are available:

- Metallic thin film strain gauge
- Ceramic thick film strain gauge

Both have different specifications. The main differences are given by:

- Available pressure measuring ranges
- Limitations of medium temperature
- Available process connection types and sizes
- With/without seal for process connection
- Flush diaphragm option available.

The device digitises the pressure value and makes it available for use through the "CANopen" digital communication interface (CAN slave).

Instead of an analogue output, this device offers the CANopen digital interface. This allows bidirectional data transfer, e.g. with a CAN/Ethernet gateway or directly to a PLC that is equipped with a CAN interface. CAN devices can also be connected to the Bürkert bus digital communication interface. A driver used for data exchange and settings of the 8312 is integrated in the Bürkert PC tool Communicator and available on our website.

Several useful auxiliary functions have been implemented through the DS 404 device profile.

## Table of contents

<b>1. General Technical Data</b>	<b>3</b>
<b>2. Approvals</b>	<b>5</b>
2.1. Pressure Equipment Directive.....	5
Device used on a pipe .....	5
Device used on a vessel .....	5
<b>3. Dimensions</b>	<b>6</b>
3.1. Ceramic version .....	6
3.2. Metallic version .....	6
<b>4. Product operation</b>	<b>7</b>
4.1. Functional overview .....	7
<b>5. Product accessories</b>	<b>8</b>
<b>6. Ordering information</b>	<b>8</b>
6.1. Bürkert eShop – Easy ordering and quick delivery.....	8
6.2. Bürkert product filter .....	8
6.3. Ordering chart.....	9
6.4. Ordering chart accessories.....	10

## 1. General Technical Data

Product properties	
<b>Material</b>	
<b>Non wetted parts</b>	
Housing	Stainless steel 1.4305 (303)
<b>Wetted parts</b>	
Process connection	<ul style="list-style-type: none"> <li>Ceramic version: stainless steel 1.4305 (303)</li> <li>Metallic version: stainless steel 1.4571 (316Ti)</li> </ul>
Measurement element	<ul style="list-style-type: none"> <li>Ceramic version: ceramic Al<sub>2</sub>O<sub>3</sub> (96 %)</li> <li>Metallic version: stainless steel 1.4435 (316L)</li> </ul>
Seal	<ul style="list-style-type: none"> <li>Ceramic version: FPM (FFPM on request)</li> <li>Metallic version: none</li> </ul>
Dimensions	Detailed information can be found in chapter <b>"3. Dimensions"</b> on page 6.
<b>Surface quality</b>	
For clamp connection	Ra < 0.8 µm
Measurement technology	<ul style="list-style-type: none"> <li>Ceramic thick film strain gauge</li> <li>Metallic thin film strain gauge</li> </ul>
Measured variable	Relative pressure (absolute pressure on request)
Measuring range	-1...5 or 0...0.25; 1; 1.6; 2.5; 4.0; 6.0; 10.0 or 16.0 bar Detailed information can be found in chapter <b>"6.3. Ordering chart"</b> on page 9.
Compensated ambient temperature range (T <sub>amb.</sub> )	-20...+85 °C (-4...+185 °F)
Monitoring	<ul style="list-style-type: none"> <li>Measuring circuit <ul style="list-style-type: none"> <li>Underrange (freely selectable lower limit)</li> <li>Overrange (freely selectable upper limit)</li> </ul> </li> <li>Probe short circuit</li> <li>Probe break</li> </ul>
Weight	95 g with process connection G ¼"
Performance data	
<b>Temperature coefficient (Tc)</b>	
Average Tc of zero	In compensated T <sup>o</sup> <sub>amb.</sub> range <ul style="list-style-type: none"> <li>Ceramic version: ≤ 0.02 % / °C typical, ≤ 0.04 % / °C max.</li> <li>Metallic version: <ul style="list-style-type: none"> <li>≤ 0.03 % / °C typical, ≤ 0.05 % / °C max. for measuring ranges ≤ 0.4 bar</li> <li>≤ 0.02 % / °C typical, ≤ 0.04 % / °C max. for measuring ranges &gt; 0.6 bar</li> </ul> </li> </ul>
Average Tc of measuring span	<ul style="list-style-type: none"> <li>Ceramic version: ≤ 0.02 % / °C typical, ≤ 0.04 % / °C max.</li> <li>Metallic version: ≤ 0.02 % / °C typical, ≤ 0.04 % / °C max.</li> </ul>
Thermal hysteresis	<ul style="list-style-type: none"> <li>Ceramic version: ≤ ± 0.4 % of measuring span</li> <li>Metallic version: <ul style="list-style-type: none"> <li>≤ ± 0.5 % of measuring span (in compensated temperature range)</li> <li>≤ ± 1 % of measuring span for range 0...0.25 bar</li> </ul> </li> </ul>
Zero offset	≤ 0.3 % of measuring span
Cycle time	1 ms
Measuring resolution	12 Bit
Overload limit	3 x measuring span
Burst pressure	4 x measuring span Detailed information on burst pressure can be found in chapter <b>"6.3. Ordering chart"</b> on page 9.
Measurement deviation	Related to characteristic curve: ≤ 0.5 % of measuring span (limit point setting)
Hysteresis	<ul style="list-style-type: none"> <li>Ceramic version: ≤ 0.2 % of measuring span</li> <li>Metallic version: ≤ 0.1 % of measuring span</li> </ul>
Repeatability	<ul style="list-style-type: none"> <li>Ceramic version: ≤ 0.1 % of measuring span</li> <li>Metallic version: ≤ 0.05 % of measuring span</li> </ul>
Stability (per year)	<ul style="list-style-type: none"> <li>Ceramic version: ≤ 1 % of measuring span</li> <li>Metallic version: ≤ 0.5 % of measuring span</li> </ul>

Electrical data	
Operating voltage	10...30 V DC, filtered and regulated
Power source (not supplied)	The auxiliary energy of the pressure sensor must meet SELV requirements; optionally, an energy-limited current circuit according to section 9.3 of DIN EN 61010-1 and UL 61010-1 can be used.
Current consumption	Max. approx. 45 mA
DC reverse polarity protection	Yes
Overvoltage protection	Yes
Short circuit protection	Yes
Cable	5-wire shielded cable, length depends on the transmission speed. The physical CAN transmission is standardized according to ISO 11898-2 (high-speed) and ISO 11898-3 (low-speed)
Medium data	
Fluid	Liquid and gaseous medium
Fluid temperature	<ul style="list-style-type: none"> <li>Ceramic version: -20...+85 °C (-4...+185 °F)</li> <li>Metallic version: -40...+125 °C (-40...+257 °F)</li> </ul>
Process/Port connection & communication	
Process connection	<ul style="list-style-type: none"> <li>Ceramic version: G ¼" or NPT ¼" (according to EN 837)</li> <li>Metallic version: <ul style="list-style-type: none"> <li>G ¼" or NPT ¼" (according to EN 837)</li> <li>G ¾" flush diaphragm (according to ISO 228-1)</li> <li>Clamp 1½" (according to ISO 2852)</li> </ul> </li> </ul> <p>Detailed information on the process connection can be found in chapter "6.3. Ordering chart" on page 9.</p>
Electrical connection	M12 × 1 male connector, 5 pin according to DIN IEC 60947-5-2
Digital communication: CANopen	
Protocol	CiA DS 301, V4.02, CANopen slave
Profile	CiA DS 404, V1.2; measuring devices and closed-loop controllers
Baud rate	20 kbaud to 1 Mbaud, setting via LSS or SDO
Node ID	1 to 127, setting via LSS or SDO
PDO	0 Rx, 1 Tx
SDO	1 Rx, 1 Tx
Emergency	Yes
Heartbeat	Yes
Node Guarding	Yes
LSS	Yes
SYNC	Yes
Operation and project design	All parameters are accessible via the CANopen object directory (EDS) and can be set via standard CANopen software tools or Bürkert Communicator.
EDS (electronic data sheet)	<ul style="list-style-type: none"> <li>Device driver in Bürkert Communicator tool Type 8920, see "Bürkert Communicator" on the website in the Software chapter <b>Type 8920</b> ▶.</li> <li>See "Device Description Files" on the website in the Software chapter <b>Type 8312</b> ▶.</li> </ul>
Factory setting	See "Operating Instructions Type 8312" on the website in the User Manuals chapter <b>Type 8312</b> ▶.
Approvals and certificates	
Standards	
Degree of protection	IP67 according to IEC/EN 60529, with M12 female connector screwed on
Directives	
CE directives	The applied standards, which verify conformity with the EU Directives, can be found on the EU Type Examination Certificate and/or the EU Declaration of conformity (if applicable)
Electromagnetic compatibility (EMC)	<p>CE conformity according to EN 61326-2-3</p> <ul style="list-style-type: none"> <li>Interference emission: class B</li> <li>Immunity to interference: to industrial requirements</li> </ul>

## Pressure equipment directives

- The device does not meet the requirements for “safety accessories” within the meaning of the Pressure Equipment Directive 2014/68/EU.
- Complying with Article 4, Paragraph 1 of 2014/68/EU directive  
Detailed information on the pressure equipment directive can be found in chapter “2.1. Pressure Equipment Directive” on page 5.

## Environment and installation

## Ambient temperature

Operation	-20...+85 °C (-4...+185 °F)
Storage	-40...+85 °C (-40...+185 °F)
Relative air humidity	<ul style="list-style-type: none"> <li>• During operation: ≤ 100 %, without condensation on the outer housing surface of the device</li> <li>• During storage: ≤ 90 %, without condensation</li> </ul>
Climate class	3K7 according to EN 60721-3-3
Area of use	Indoors and outdoors (protect this device against electromagnetic interference, ultraviolet rays and the effects of climatic conditions)
Vibration resistance	20 g max. with 15...2000 Hz according to EN 60068-2-6
Shock resistance	100 g, 5 ms according to EN 60068-2-27
Mounting position	<ul style="list-style-type: none"> <li>• Installation: unrestricted</li> <li>• Calibration: device upright, process connection at the bottom</li> </ul>

## 2. Approvals

### 2.1. Pressure Equipment Directive

The device conforms to Article 4, Paragraph 1 of the Pressure Equipment Directive 2014/68/EU under the following conditions:

#### Device used on a pipe

**Note:**

- The data in the table is independent of the chemical compatibility of the material and the fluid.
- PS = maximum admissible pressure, DN = nominal diameter of the pipe

Type of fluid	Conditions
Fluid group 1, Article 4, Paragraph 1.c.i	DN ≤ 25
Fluid group 2, Article 4, Paragraph 1.c.i	DN ≤ 32 or PS*DN ≤ 1000
Fluid group 1, Article 4, Paragraph 1.c.ii	DN ≤ 25 or PS*DN ≤ 2000
Fluid group 2, Article 4, Paragraph 1.c.ii	DN ≤ 200 or PS ≤ 10 or PS*DN ≤ 5000

#### Device used on a vessel

**Note:**

- The data in the table is independent of the chemical compatibility of the material and the fluid.
- PS = maximum admissible pressure, V = vessel volume

Type of fluid	Conditions
Fluid group 1, Article 4, Paragraph 1.a.i	V > 1 L and PS*V ≤ 25 bar.L or PS ≤ 200 bar
Fluid group 2, Article 4, Paragraph 1.a.i	V > 1 L and PS*V ≤ 50 bar.L or PS ≤ 1000 bar
Fluid group 1, Article 4, Paragraph 1.a.ii	V > 1 L and PS*V ≤ 200 bar.L or PS ≤ 500 bar
Fluid group 2, Article 4, Paragraph 1.a.ii	PS > 10 bar and PS*V ≤ 10000 bar.L or PS ≤ 1000 bar

### 3. Dimensions

#### 3.1. Ceramic version

**Note:**

Dimensions in mm

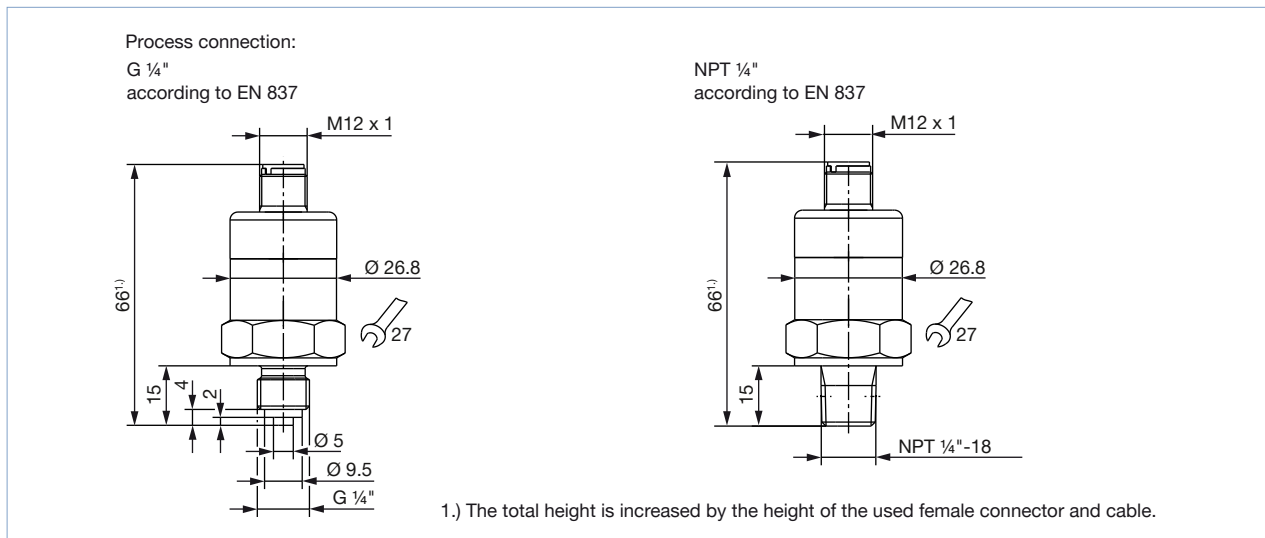

#### 3.2. Metallic version

**Note:**

Dimensions in mm

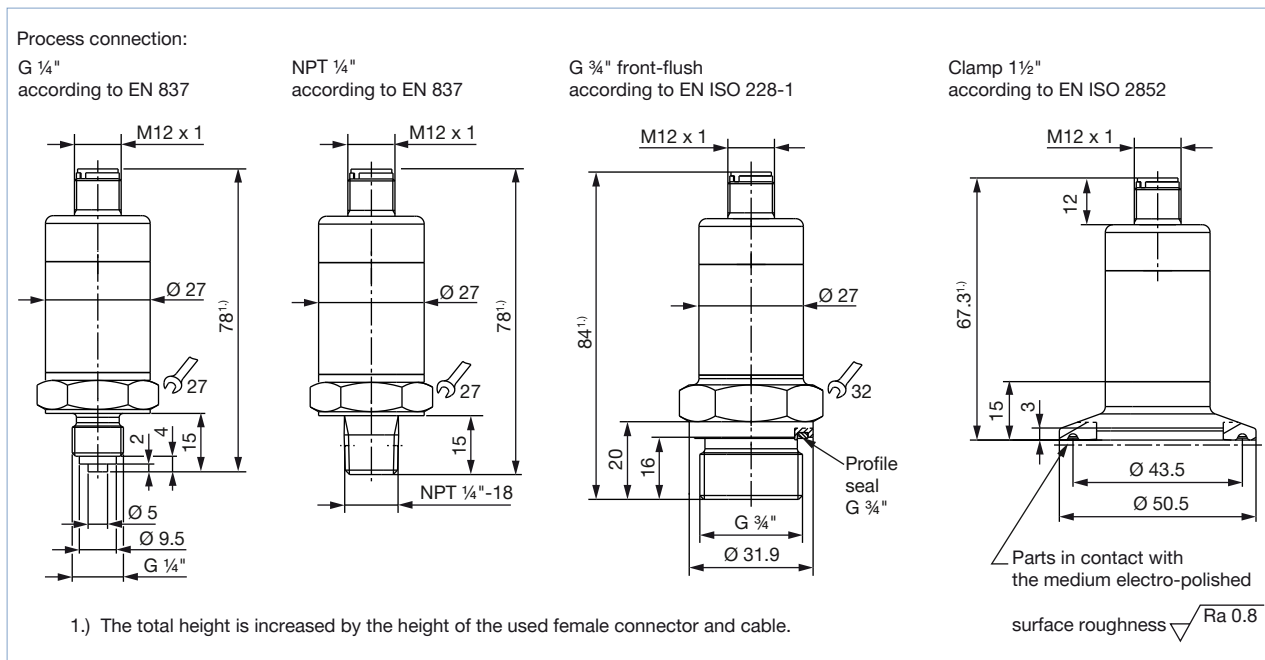

DTS 1000416947 EN Version: B Status: RL (released | freigegeben | valide) printed: 06.07.2021

## 4. Product operation

### 4.1. Functional overview

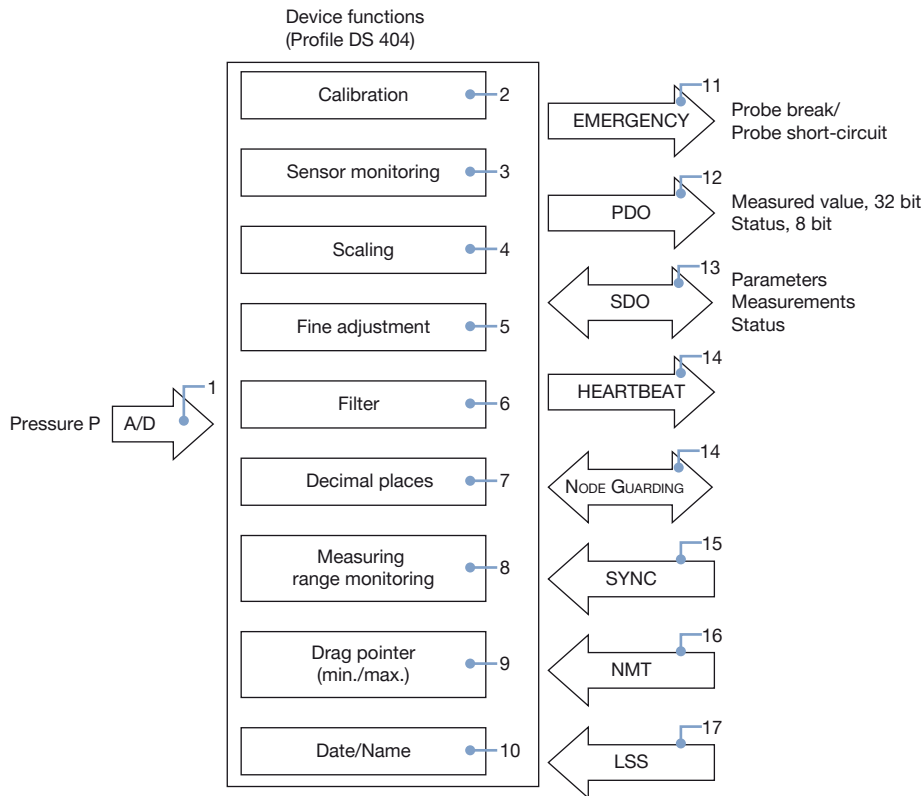

No.	Description
1	The analog signal from the pressure cell is digitized with 12 Bit resolution.
2	The pressure signal is digitally calibrated at the factory.
3	The sensor monitoring facility continuously checks the correct performance of the sensor signal and triggers high priority emergency telegrams in the event of an error.
4	The pressure measurement can be scaled to any dimensional unit (or in % of range).
5	Fine calibration features and auto-zeroing function and a freely adjustable shift of the characteristic.
6	Undesirable signal fluctuations can be suppressed through the constant (adjustable) filter.
7	The measurement output has a freely selectable decimal place.
8	Free choice of upper and lower limits for range monitoring. The result is given as a status byte in addition to the measurement in the PDO frame.
9	The drag pointer ("min./max. index") function records the minimum and maximum pressure values.
10	Date and name of the last servicing action can be stored.
11	An emergency telegram is triggered in the event of a sensor fault.
12	The PDO frame contains a 32-bit measurement and a 8-bit status. The measurement output can be controlled by means of different trigger conditions.
13	Parameters can be set through SDO frames, and measurements and status can be requested.
14	The heartbeat signal or Node Guarding can be used to additionally monitor the transmitter function.
15	The transmission of measurements can be controlled through the Sync command.
16	NMT frames serve to control the operational state of the transmitter.
17	The CAN Node ID and CAN baud rate are set via LSS or SDO, according to choice.

## 5. Product accessories

**Note:**

To set up a device, please use the USB-büS interface in combination with the Bürkert software tool Communicator Type 8920.

See **Software manual Type 8920** ▶ for more information.

Accessories	No.	Description
	1	Quick-Start
	2	Power supply: 100...240 V AC/24 V DC 1 A and adaptors for power supply worldwide use
	3	büS terminating resistor on büS Y-splitter
	4	5 pin M12 male connector wired on free end cable
	5	büS connection cable with 5 pin M12 plug, micro USB B plug
	6	büS adapter with 5 pin M12 plug, A-coded to 5 pin M12 plug, A-coded
	7	büS stick (USB to büS/CANopen adaptor)
	8	büS service cable with 5 pin M12 plug, mini USB and circular plug-in connectors for power supply
	9	Magnetic key
	10	CD - Communicator (30-day license without registration, update and licensing over Bürkert home page). It is recommended to download and install the Communicator software from the homepage to use the latest version.

## 6. Ordering information

### 6.1. Bürkert eShop – Easy ordering and quick delivery



**Bürkert eShop – Easy ordering and fast delivery**

You want to find your desired Bürkert product or spare part quickly and order directly? Our online shop is available for you 24/7. Sign up and enjoy all the benefits.

[Order online now](#)

### 6.2. Bürkert product filter



**Bürkert product filter – Get quickly to the right product**

You want to select products comfortably based on your technical requirements? Use the Bürkert product filter and find suitable articles for your application quickly and easily.

[Try out our product filter](#)



### 6.3. Ordering chart

**Note:**

All following versions have a 10...30 V DC operating voltage and a CANopen digital interface.

Process connection	Seal	Pressure range (relative pressure)	Burst pressure (relative pressure)	Article no.
		[bar]	[bar]	
<b>Ceramic version</b>				
G ¼"	FPM	0...1.6	6.4	574590
		0...2.5	10	574591
		0...4	16	574592
		0...6	24	574593
		0...10	40	574594
		0...16	64	574595
NPT ¼"	FPM	0...1.6	6.4	574596
		0...2.5	10	574597
		0...4	16	574598
		0...6	24	574599
		0...10	40	574600
		0...16	64	574601
<b>Metallic version</b>				
G ¼"	-	0...0.25	1	574602
		0...1	4	574603
NPT ¼"	-	0...0.25	1	574604
		0...1	4	574605
G ¾" flush diaphragm	-	0...0.25	1	574606
		0...1	4	574607
		0...1.6	6.4	574608
		0...2.5	10	574609
		0...4	16	574610
		0...6	24	574611
		0...10	40	574612
		0...16	64	574613
Clamp 1½"	-	-1...5	20	572106
		0...0.25	1	572106
		0...1	4	572105
		0...1.6	6.4	572104
		0...2.5	10	572103
		0...4	16	572102
		0...10	40	572101
0...16	64	572100		

#### Further versions on request

**Process connection**

G ½"

**Pressure**

- Relative pressure: up to 600 bar or 8700 PSI
- Absolute pressure: up to 25 bar or 360 PSI

**Material**



















Seal: FFPM<sup>1.)</sup> for ceramic version

1.) Product characteristics similar to PTFE

#### 6.4. Ordering chart accessories

**Note:**

- büS communication specifications are based on CANopen.
- All following accessories can be used for CANopen as well.

Description	Article no.
<b>System connection</b>	
<b>Type ME43 Gateway / Interface</b>	
büS/Ethernet (Profinet, Ethernet/IP, Modbus TCP, EtherCAT)	307390 
büS/Profibus DP	307393 
<b>Interface accessories</b>	
<b>büS Stick Set</b>	
 USB-büS Interface Set 1, Type 8920. Detailed information can be found in chapter “5. Product accessories” on page 8.	772426 
USB-büS Interface Set 2, Type 8920 (only büS Stick, cable and büS service cable)	772551 
<b>Connectors and sockets</b>	
büS Y-connector, 5 pin M12 female to 5 pin M12 male and 5 pin M12 female	772420 
büS Y-connector, 5 pin M12 female to 5 pin M12 male and 5 pin M12 female (power interrupt)	772421 
büS adaptor M12 male A-coded - M12 male A-coded	772867 
büS termination, 5 pin M12 male cable plug	772424 
büS termination, 5 pin M12 female cable plug	772425 
<b>Extensions</b>	
 5 pin M12 female and male straight cable plug moulded on cable (0.5 m, shielded)	772403 
5 pin M12 female and male straight cable plug moulded on cable (1 m, shielded)	772404 
5 pin M12 female and male straight cable plug moulded on cable (3 m, shielded)	772405 
5 pin M12 female and male straight cable plug moulded on cable (5 m, shielded)	772406 
5 pin M12 female and male straight cable plug moulded on cable (10 m, shielded)	772407 
5 pin M12 female and male straight cable plug moulded on cable (20 m, shielded)	772408 
<b>Software</b>	
Software Bürkert Communicator	Download Type 8920 

# Bürkert – Close to You

For up-to-date addresses  
please visit us at  
[www.burkert.com](http://www.burkert.com)

DTS 1000416947 EN Version: B Status: RL (released | freigegeben | validé) printed: 06.07.2021

