







Inline flowmeter or batch controller with paddle wheel

- Up to PN 16, size of measuring tube: DN 06 to DN 65
- Display for indication of flow rate and volume with two totalizers or dosing
- Automatic calibration using Teach-In
- Inputs (with batch controller) and all outputs can be checked without the need for actual flow
- Total and day counters for batch quantity and number of dosing, volume or mass counter indicator (with batch controller)



Product variants described in the data sheet may differ from the product presentation and description.

Can be combined with

- 
Type 8611
eCONTROL - Universal controller
▶
- 
Type 8619
multiCELL - Multi-channel and multi-function transmitter/controller
▶
- 
Type 8802
ELEMENT continuous control valve systems - overview
▶
- 
Type 8644
Remote Process Actuation Control System AirLINE
▶

Type description

The Type 8035 flowmeter or batch controller is specially designed for use in neutral, slightly aggressive, solid free liquids.

The flowmeter or batch controller is made up of a compact sensor-fitting with paddle wheel (S030) and a transmitter (SE35) which are quickly and easily connected together by a bayonet fitting. The Bürkert designed sensor-fitting system ensures simple installation of the devices into all pipelines from DN 06...DN 65.

The flowmeter with paddle wheel sensor is available in two versions:

- standard signal output version or
- battery powered indicator/totalizer version without output.

Table of contents

1. General technical data	4
1.1. About the device.....	4
1.2. All versions.....	4
1.3. Inline flowmeter.....	6
1.4. Batch controller	7
2. Product versions	8
2.1. Inline flowmeter.....	8
2.2. Batch controller	9
3. Approvals	9
3.1. Certification UL.....	9
3.2. Pressure Equipment Directive.....	9
Device used on a pipe	9
4. Materials	9
4.1. Chemical Resistance Chart – Bürkert resistApp.....	9
4.2. Material specifications	10
Inline flowmeter.....	10
Batch controller	11
5. Dimensions	12
5.1. Transmitter SE35 with cable plug (EN 175301-803)	12
5.2. Transmitter SE35 with M20 x 1.5 cable glands.....	12
5.3. Transmitter SE35 with battery powered indicator/totalizer	13
5.4. Transmitter SE35 mounted in a S030 sensor-fitting	13
6. Performance specifications	14
6.1. Pressure temperature diagram.....	14
7. Product installation	14
7.1. Installation notes.....	14
8. Product operation	15
8.1. Measuring principle	15
8.2. Functional overview	16
Display and operating keys.....	16
Inline flowmeter with a standard output signal	17
Inline flowmeter as battery powered indicator/totalizer	17
Batch controller	18
8.3. Function modes	19
Inline flowmeter with a standard output signal	19
Batch controller	19
9. Product design and assembly	20
9.1. Product assembly	20
10. Networking and combination with other Bürkert products	20
10.1. Inline flowmeter with a standard output signal	20
10.2. Batch controller	21

11. Ordering information	21
11.1. Bürkert eShop – Easy ordering and quick delivery.....	21
11.2. Recommendation regarding product selection	21
11.3. Bürkert product filter.....	21
11.4. Ordering chart.....	22
Inline flowmeter.....	22
Batch controller	22
11.5. Ordering chart accessories.....	22

1. General technical data

1.1. About the device

The device Type 8035 is available as a Inline flowmeter or a batch controller in a compact version. Furthermore, the Inline flowmeter is available either as a measuring device with a standard output signal or as a battery powered indicator/totalizer without output.

1.2. All versions

The following data are valid for both the Inline flowmeter and the batch controller.

Product properties

Material

Please make sure the device materials are compatible with the fluid you are using.

Detailed information can be found in chapter [“4.1. Chemical Resistance Chart – Bürkert resistApp” on page 9](#).

Non wetted parts

Housing, cover	PC
Lid	PC
Front panel foil	Polyester
Screws	Stainless steel
Cable glands	PA

Wetted parts

Sensor-fitting body, sensor armature	Brass, stainless steel, PVC, PP or PVDF (depending on S030 version)
Seal	FKM or EPDM (depending on S030 version)
Axis and bearings	Ceramics (Al ₂ O ₃)
Paddle wheel	PVDF

Dimensions Detailed information can be found in chapter [“5. Dimensions” on page 12](#).

Measuring principle Paddle wheel

Compatibility Any pipe from DN 06...DN 65 which is fitted with Bürkert S030 Inline sensor-fitting. For the selection of the nominal diameter of the Inline sensor-fittings, see [data sheet Type S030](#) ▶.

Display 15 × 60 mm, 8-digit LCD, alphanumeric, 15 segments, 9 mm high

Pipe diameter DN 06...DN 65

Measuring range

- Flow rate: 0.5...1000 l/min (0.13...265 gpm)
- Flow velocity: 0.3...10 m/s

Performance data

Measurement deviation

- Teach-In: ± 1 % of the measured value¹⁾ at Teach-In flow rate value
- Standard K-factor: ± 2.5 % of the measured value¹⁾

Linearity ± 0.5 % of full scale¹⁾

Repeatability ± 0.4 % of the measured value¹⁾

Electrical data

Power source (not supplied) Limited power source according to UL/EN 60950-1 standards or limited energy circuit according to UL/EN 61010-1 §9.4

DC reverse polarity protection Yes

Overvoltage protection Yes

Voltage supply cable

- Cable with maximum operating temperature greater than 80 °C (176 °F) (90 °C (194 °F) for UL-Recognized version)
- Shielded
- Max. 50 m length

Medium data

Fluid temperature With sensor-fitting Type S030 in:

- PVC: 0...+50 °C (+32...+122 °F)
- PP: 0...+80 °C (+32...+176 °F)
- PVDF, stainless steel or brass: -15...+100 °C (+5...+212 °F)

See [data sheet Type S030](#) ▶ for more information.

Fluid pressure	<ul style="list-style-type: none"> • PN 10 with plastic sensor-fitting • PN 16 (PN 40 on request) with metal sensor-fitting Detailed information can be found in the data sheet of the Inline sensor-fittings, see data sheet Type S030 ▶ for more information.
Viscosity	Max. 300 cSt
Rate of solid particles	Max. 1 %
Maximum particle size	0.5 mm
Process/Port connection & communication	
Port connection	<ul style="list-style-type: none"> • Metal: Internal or external thread, weld ends, clamp or flange • Plastic: true union with nut and solvent/fusion socket, spigot or external thread See data sheet Type S030 ▶ for more information.
Approvals and certificates	
Standards	
Degree of protection ^{2.)} according to IEC/EN 60529	IP65 under the following conditions: device wired, cover and lid screwed tight and cable plug or glands mounted and tightened or with blind plug if not used
Directives	
CE directives	The applied standards, which verify conformity with the EU Directives, can be found on the EU Type Examination Certificate and/or the EU Declaration of conformity (if applicable).
Pressure Equipment Directive	Complying with Article 4, Paragraph 1 of 2014/68/EU directive Detailed information on the pressure equipment directive can be found in chapter "3.2. Pressure Equipment Directive" on page 9.
Certification	UL-Recognized for US and Canada
Environment and installation	
Relative air humidity	≤ 80 %, without condensation
Height above sea level	Max. 2000 m
Operating conditions	Continuous
Equipment mobility	Fixed
Application range	Indoor and outdoor (protect the device against electromagnetic interference, ultraviolet rays and, when installed outdoors, against the effects of climatic conditions)
Installation category	Category I according to UL/EN 61010-1
Pollution degree	Degree 2 according to UL/EN 61010-1

1.) Under reference conditions i.e. measuring fluid = water, ambient and water temperature = 20 °C (68 °F), while maintaining the minimum inlet and outlet distances and the appropriate internal diameters of the pipes.

2.) Not evaluated by UL

1.3. Inline flowmeter

Note:

If the device is mounted in a humid environment or outside, then the maximum voltage allowed is **35 V DC** instead of 36 V DC.

Product properties

Material

- | | |
|-----------------------------------|---|
| Female cable plug/male fixed plug | <ul style="list-style-type: none"> • Body, contact holder and cable gland in PA • Cable gland seal and flat seal in NBR |
|-----------------------------------|---|

Performance data

- | | |
|------------------------------|----------------|
| 4...20 mA output uncertainty | ± 1 % of range |
|------------------------------|----------------|

Electrical data

Operating voltage (V+)	<p>Measuring device with a standard output signal</p> <ul style="list-style-type: none"> • 12...36 V DC ± 10 %, filtered and regulated Connection to main supply: permanent (through external SELV (Safety Extra Low Voltage) and LPS (Limited Power Source) power supply • 115/230 V AC, 50/60 Hz Voltage supply available inside the device: <ul style="list-style-type: none"> – supplied voltage: 27 V DC regulated – maximum current: 125 mA – integrated protection: 125 mA time delay fuse <p>Battery powered indicator/totalizer</p> <ul style="list-style-type: none"> • 4 x 1.5 V DC non-rechargeable alkaline AA batteries, lifetime 4 years at 20 °C (68 °F)
Current consumption	<p>12...36 V DC powered measuring device with a standard output signal, with sensor and without pulse output consumption</p> <ul style="list-style-type: none"> • With relays: ≤ 70 mA • Without relay: ≤ 25 mA :
Power consumption	115/230 V AC powered measuring device: 3 VA
Outputs	<p>Measuring device with a standard output signal</p> <ul style="list-style-type: none"> • Pulse (potential free transistor): <ul style="list-style-type: none"> – polarized, NPN or PNP (wiring dependant) – function: pulse output, adjustable pulse value – 0...400 Hz – 5...36 V DC, 100 mA, voltage drop at 100 mA: 2.5 V DC – duty cycle (pulse duration/period): 0.5 – galvanic insulation and protected against overvoltage, polarity reversals and short circuit • Relay: <ul style="list-style-type: none"> – 2 relays, hysteresis, adjustable thresholds, normally open – non UL recognized device: 230 V AC/3 A or 40 V DC/3 A (resistive load) – UL recognized device: 30 V AC/42 V_{peak}/3 A or 60 V DC/1 A • Current: <ul style="list-style-type: none"> – 4...20 mA (3-wire with relays; 2-wire without relay) – sourcing or sinking (wiring dependant) – max. loop impedance: 900 Ω at 30 V DC, 600 Ω at 24 V DC, 50 Ω at 12 V DC, 800 Ω with a 115/230 V AC voltage supply – response time (10...90 %) for the measured value: 6 s (default) <p>Battery powered indicator/totalizer</p> <ul style="list-style-type: none"> • Without output

Voltage supply cable	Measuring device with a standard output signal <ul style="list-style-type: none"> External diameter (cable): <ul style="list-style-type: none"> 5...8 mm (with cable plug) 6...12 mm (1 cable per cable gland) or 3...5 mm when using a multi-way seal (2 cables per cable gland) Cross section of wires: <ul style="list-style-type: none"> 0.25...1.5 mm² (with cable plug) 0.75 mm² (with cable gland) Cross section the local ground wire: max. 0.75 mm²
	Battery powered indicator/totalizer <ul style="list-style-type: none"> None

Process/Port connection & communication

Electrical connection	<ul style="list-style-type: none"> Version 12...36 V DC: cable plug or cable glands M20 × 1.5 Version with batteries: None
-----------------------	--

Environment and installation

Ambient temperature	Operation and storage: <ul style="list-style-type: none"> Version 12...36 V DC: -10...+60 °C (+5...+140 °F) Version 115/230 V AC: -10...+50 °C (+5...+122 °F) Version with batteries: -10...+55 °C (+5...+131 °F)
---------------------	--

1.4. Batch controller

Note:

If the device is mounted in a humid environment or outside, then the maximum voltage allowed is **35 V DC** instead of 36 V DC.

Electrical data

Operating voltage (V+)	<ul style="list-style-type: none"> 12...36 V DC, max tolerance: -5 % or +10 % at 12 V DC, ±10 % at 36 V DC, filtered and regulated Connection to main supply: permanent (through external SELV (Safety Extra Low Voltage) and LPS (Limited Power Source) power supply) 115/230 V AC, 50/60 Hz Voltage supply available inside the device: <ul style="list-style-type: none"> supplied voltage: 27 V DC regulated maximum current: 125 mA integrated protection: 125 mA time delay fuse
Current consumption	With sensor, without consumption of digital input and pulse output <ul style="list-style-type: none"> With relays: <ul style="list-style-type: none"> ≤100 mA (at 12 V DC) ≤50 mA (at 36 V DC) ≤55 mA (115/230 V AC) Without relay: <ul style="list-style-type: none"> ≤70 mA (at 12 V DC) ≤35 mA (at 36 V DC) ≤40 mA (115/230 V AC)
Power consumption	115/230 V AC powered measuring device: 3 VA
Inputs	<ul style="list-style-type: none"> DI (1 to 4) Switching threshold V_{on}: 5...36 V DC Switching threshold V_{off} max.: 2 V DC Min. pulse duration: 100 ms Input impedance: 9.4 KOhms Galvanic insulation, protected against polarity reversals and voltage spike

Outputs	<ul style="list-style-type: none"> • Transistors (DO1 and DO4): <ul style="list-style-type: none"> – NPN or PNP (wiring dependant), potential-free – function: pulse output (by default for DO1), batch state (by default for DO4), configurable and parametrisable – 0...300 Hz – 5...36 V DC, 100 mA max., voltage drop at 100 mA: 2.7 V DC – duty cycle (pulse duration/period): >0.45 – galvanic insulation, protected against overvoltage, polarity reversals and short-circuits • Relays (DO2 and DO3): <ul style="list-style-type: none"> – 2 relays (normally open), parametrisable (by default: DO2 always configured to control the valve, parametrized of 100 % of the batch quantity and DO3 configured as alarm) – non UL recognized device: 230 V AC/3 A or 40 V DC/3 A (resistive load) – UL recognized device: 30 V AC/42 V_{peak}/3 A or 60 V DC/1 A – max. cutting power of 750 VA (resistive load)
Voltage supply cable	<ul style="list-style-type: none"> • External diameter (cable): <ul style="list-style-type: none"> – 6...12 mm (1 cable per cable gland) or – 4 mm when using a multi-way seal (2 cables per cable gland) • Cross section of wires: 0.75 mm²

Process/Port connection & communication	
Electrical connection	Cable glands M20 x 1.5
Environment and installation	
Ambient temperature	Operation and storage: <ul style="list-style-type: none"> • Version 12...36 V DC: -10...+60 °C (+5...+140 °F) • Version 115/230 V AC: -10...+50 °C (+5...+122 °F)

2. Product versions

2.1. Inline flowmeter

Note:

The Inline flowmeter is available in two versions:

- Inline flowmeter with standard output signal (4...20 mA, frequency)
- Inline flowmeter as battery powered indicator/totalizer



Inline flowmeter with standard output signal

The device makes it possible to switch a solenoid valve, activate an alarm or generate a flow rate proportional frequency, thanks to a digital output and, for some versions, by means of two relay outputs, fully configurable, and to establish a control loop thanks to a 4...20 mA current output.

The device is equipped with a 4...20 mA current output (analogue output), a digital output (pulse output) and two totalizers.

Some versions are also fitted with two relay outputs.

The device operates on a 2- or 3-wire system and needs a 12...36 V DC or a 115/230 V AC power supply.



Inline flowmeter as battery powered indicator/totalizer

The device has no output and displays the instantaneous value as well the amount of liquid that has flowed through.

2.2. Batch controller



When mounted in a pipe in series with one or two valves, the batch controller makes it possible to carry out a dosing of one or several quantities of liquids. The unit controls the opening of the valves and measures the quantity of the fluid which flows. The unit also closes the valves when the pre-set quantity has been delivered.

The electronic component needs a voltage supply of 12...36 V DC or 115/230 V AC. The device is equipped

- 4 digital inputs (DI1 to DI4)
- two transistor outputs (DO1 configured as a pulse output and DO4 configured as state output, by default)
- two relay outputs (DO2 always configured to control the valve and by default parametrise of 100 % of the batch quantity and DO3 configured as alarm output by default)
- two volume or mass totalizers and two batch totalizers

The second relay output can be used to activate another valve, to initiate alarms or to generate warnings.

3. Approvals

3.1. Certification UL

Certificate	Description
	<p>UL-Recognized for USA and Canada Products are UL-certified products and comply also with the following standards:</p> <ul style="list-style-type: none"> • UL 61010-1 • CAN/CSA-C22.2 No.61010-1

3.2. Pressure Equipment Directive

The device conforms to Article 4, Paragraph 1 of the Pressure Equipment Directive 2014/68/EU under the following conditions:

Device used on a pipe

Note:

- The data in the table is independent of the chemical compatibility of the material and the fluid.
- PS = maximum admissible pressure, DN = nominal diameter of the pipe

Type of fluid	Conditions
Fluid group 1, Article 4, Paragraph 1.c.i	DN ≤ 25
Fluid group 2, Article 4, Paragraph 1.c.i	DN ≤ 32 or PS*DN ≤ 1000
Fluid group 1, Article 4, Paragraph 1.c.ii	DN ≤ 25 or PS*DN ≤ 2000
Fluid group 2, Article 4, Paragraph 1.c.ii	DN ≤ 200 or PS ≤ 10 or PS*DN ≤ 5000

4. Materials

4.1. Chemical Resistance Chart – Bürkert resistApp

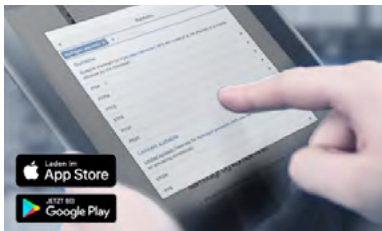

Bürkert resistApp – Chemical Resistance Chart

You want to ensure the reliability and durability of the materials in your individual application case? Verify your combination of media and materials on our website or in our resistApp.

[Start Chemical Resistance Check](#)

4.2. Material specifications

Inline flowmeter

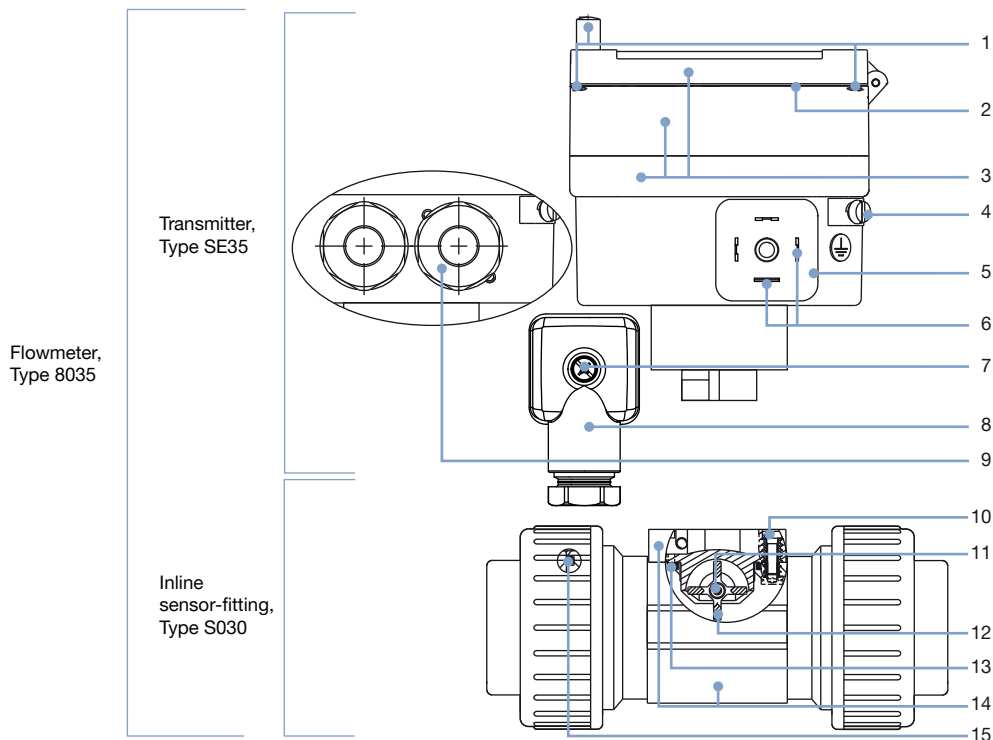

No.	Description	Material
1	Screws	Stainless steel
2	Front panel folio	Polyester
3	Housing, cover, lid	PC
4	Screws	Stainless steel
5	Male fixed plug (EN 175301-803)	PA
6	Electrical contact	Sn
7	Screw	Stainless steel
8	Female cable plug (EN 175301-803)	<ul style="list-style-type: none"> Body, contact holder and cable gland in PA Cable gland seal and flat seal in NBR
9	M20x1.5 cable gland	PA
10	Screws	Stainless steel
11	Axis and bearings	Ceramics (Al ₂ O ₃)
12	Paddle wheel	PVDF
13	Seal	FKM or EPDM (depending on S030 version)
14	Sensor-fitting body, sensor armature	Stainless steel (316L - 1.4404), brass (CuZn ₃₉ Pb ₂), PVC, PP, PVDF (depending on S030 version)
15	Seals	FKM or EPDM (depending on S030 version and only for true union connection)

DTS 1000011089 EN Version: S Status: RL (released | freigegeben | validé) printed: 09.02.2022

Batch controller

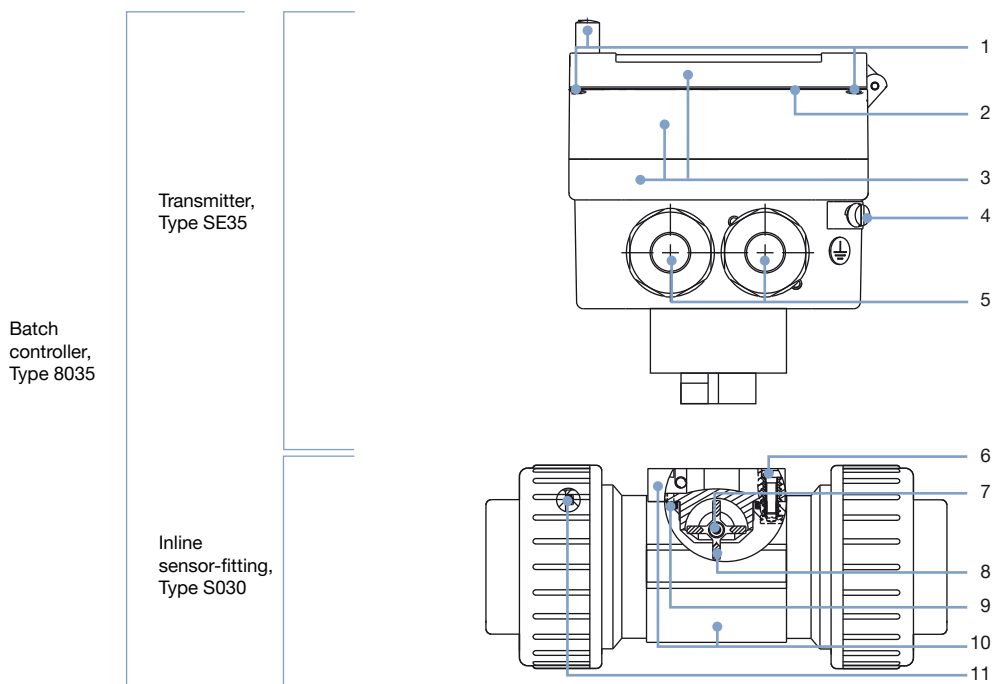

No.	Description	Material
1	Screws	Stainless steel
2	Front panel folio	Polyester
3	Housing, cover, lid	PC
4	Screws	Stainless steel
5	M20x1.5 cable gland	PA
6	Screws	Stainless steel
7	Axis and bearings	Ceramics (Al ₂ O ₃)
8	Paddle wheel	PVDF
9	Seal	FKM or EPDM (depending on S030 version)
10	Sensor-fitting body, sensor armature	Stainless steel (316L - 1.4404), brass (CuZn ₃₉ Pb ₂), PVC, PP, PVDF (depending on S030 version)
11	Seals	FKM or EPDM (depending on S030 version and only for true union connection)

DTS 1000011089 EN Version: S Status: RL (released | freigegeben | validé) printed: 09.02.2022

5. Dimensions

5.1. Transmitter SE35 with cable plug (EN 175301-803)

Note:

- Dimensions in mm
- Inline flowmeter with standard output signal

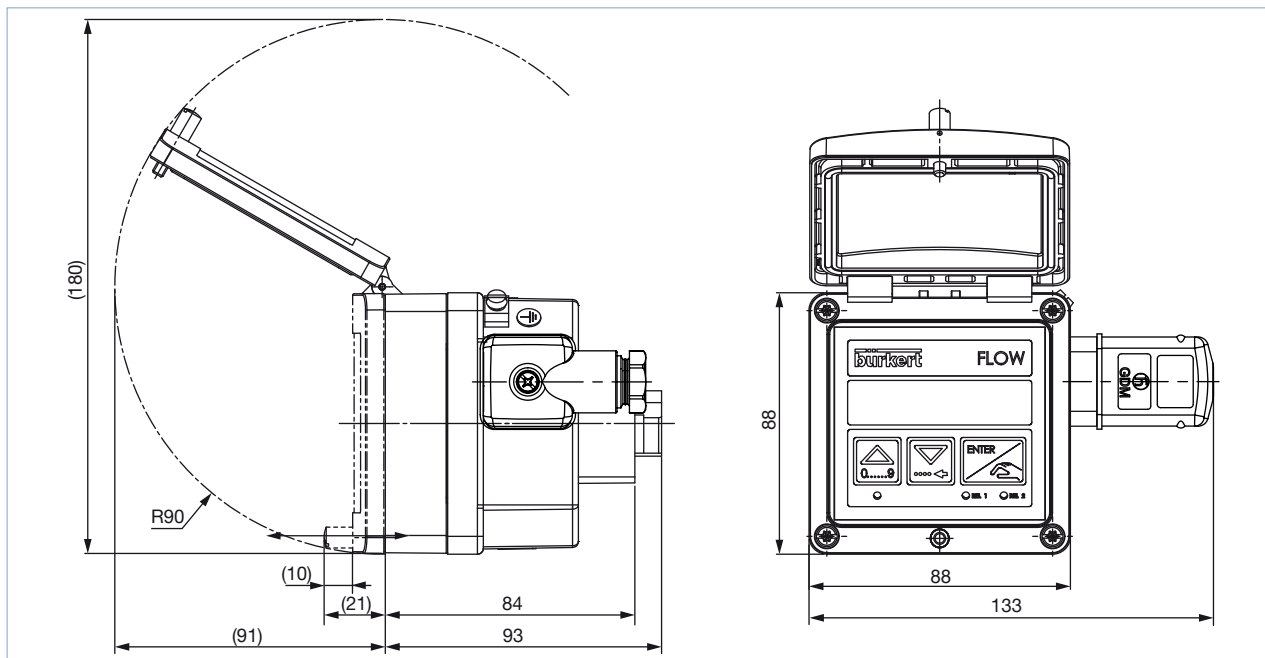

5.2. Transmitter SE35 with M20x1.5 cable glands

Note:

- Dimensions in mm
- Inline flowmeter with standard output signal or batch controller

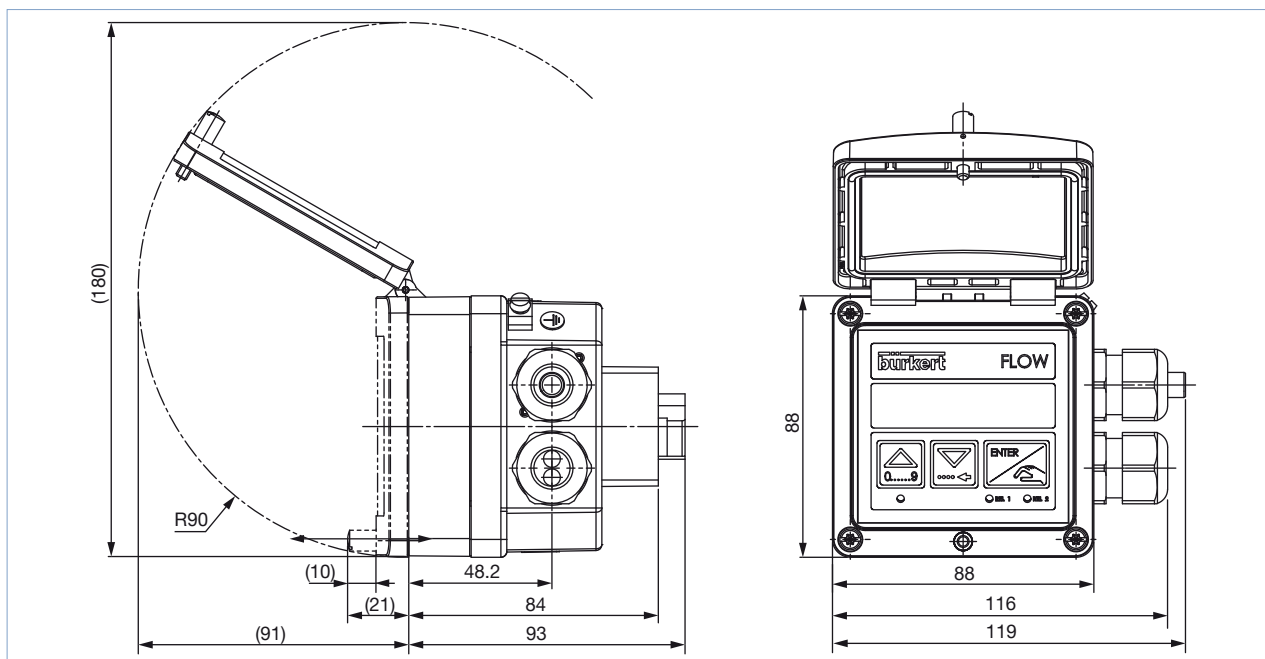

5.3. Transmitter SE35 with battery powered indicator/totalizer

Note:
Specifications in mm

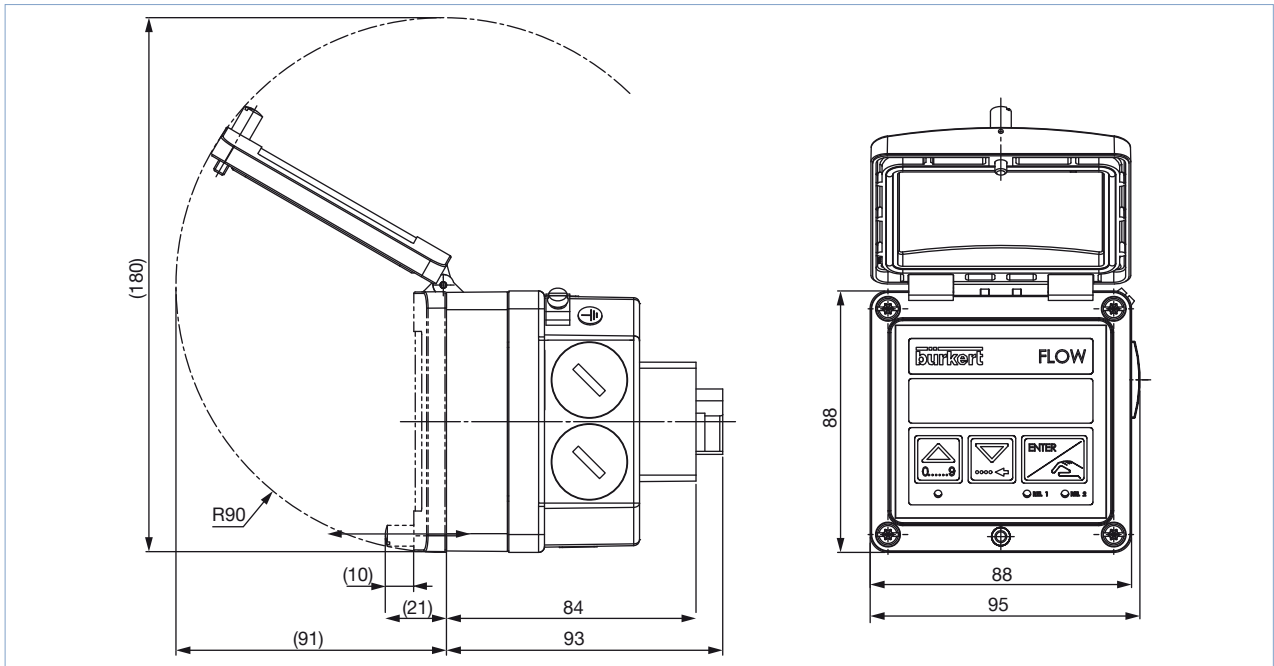

5.4. Transmitter SE35 mounted in a S030 sensor-fitting

Note:
Specifications in mm

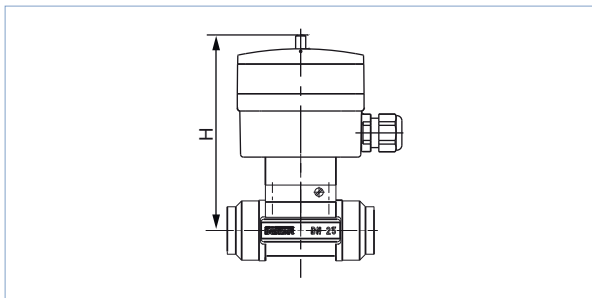

DN	H
06	134
08	134
15	139
20	137
25	137
32	140
40	144
50	151
65	151

6. Performance specifications

6.1. Pressure temperature diagram

Note:

The following diagram applies to the Inline flowmeter or batch controller.

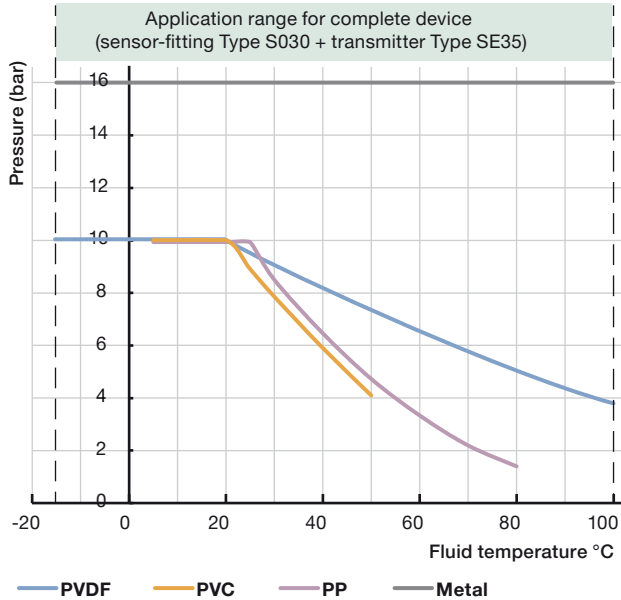

7. Product installation

7.1. Installation notes

Note:

The device is not designed for gas and steam flow measurement.

Minimum straight upstream and downstream distances must be observed. According to the pipe's design, necessary distances can be bigger or use a flow conditioner to obtain the best accuracy.

For more information, please refer to EN ISO 5167-1.

EN ISO 5167-1 prescribes the straight inlet and outlet distances that must be complied with when installing fittings in pipe lines in order to achieve calm flow conditions. The most important layouts that could lead to turbulence in the flow are shown below, together with the associated prescribed minimum inlet and outlet distances.

Make sure that the measuring conditions at the point of measurement are calm and problem-free.

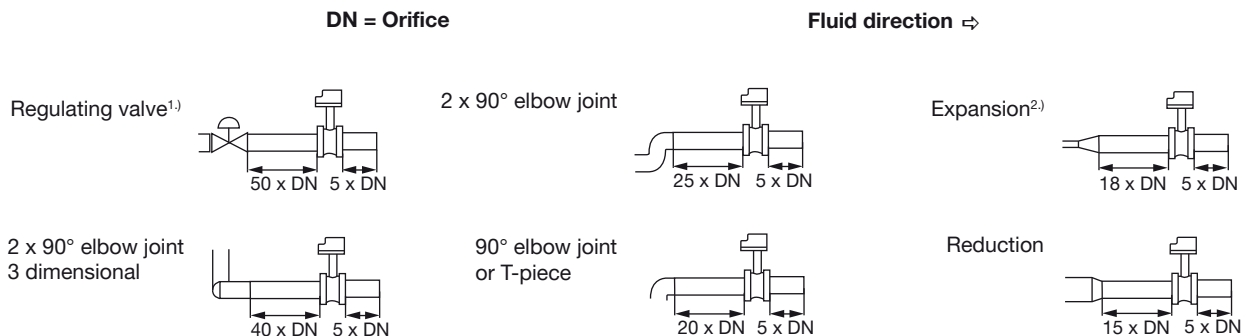

1.) If the valve cannot be mounted after the measuring device, the minimal distances have to be respected.

2.) If an expansion cannot be avoided, the minimal distances have to be respected.

Please note minimum flow velocity

The device can be installed into either horizontal or vertical pipes.

Important criteria for this are; ensure that the measurement pipe is fully filled and that the measurement pipe is air bubble free.

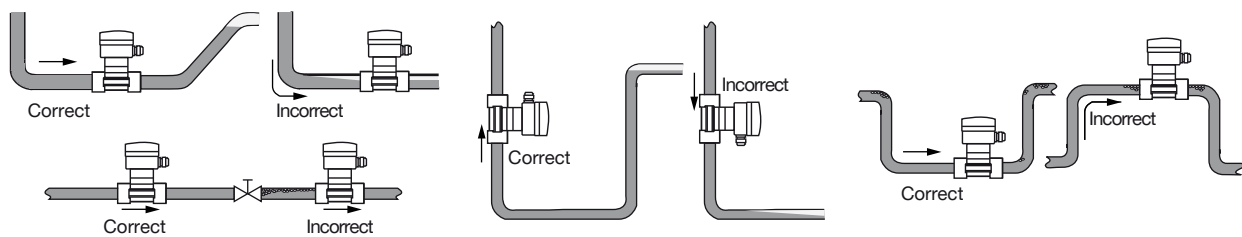

Pressure and temperature ratings must be respected according to the selected sensor-fitting material. The suitable pipe size is selected using the diagram for selecting the nominal diameter of the sensor-fitting, see **data sheet Type S030** ▶ for more information.

8. Product operation

8.1. Measuring principle

When liquid flows through the pipe, the paddle wheel with 4 inserted magnets is set in rotation, producing a measuring signal in the sensor (coil for battery indicator/totalizer version or Hall for other versions). The frequency modulated induced voltage is proportional to the flow velocity of the fluid.

A K-factor (available in the **instruction manual of the S030 sensor-fitting** ▶), specific to each pipe (size and material) enables the conversion of this frequency into a flow rate.

Inline flowmeter:

The electronic component converts the measured signal into several outputs (according to the Inline flowmeter version) and displays the actual value. Totalizers are used to obtain the volume of fluid passed through the pipe.

The electrical connection for the Inline flowmeter with standard output signal is provided via a cable plug according to EN 175301-803 or two cable glands (according to the Inline flowmeter version).

Batch controller:

The electronic component converts the measured signal and displays the actual value of the volume or mass. The electrical connection is provided via two cable glands.

8.2. Functional overview

Display and operating keys

The display is used to:

- read the value of certain parameters e.g. for the Inline flowmeter, the measured flow rate, the main totalizer
- set parameters of the device by means of 3 keys
- read the configuration of the device
- get notification of some events

Display and operating keys	No.	Description
	1	“Back” key: <ul style="list-style-type: none"> • to change the value (0...9) of the selected digit • to go back to the previous function • Read the batches history (only for batch controller)
	2	“Next” key: <ul style="list-style-type: none"> • to select the digit at the left • to go to the next function • read messages (only with Inline flowmeter as battery powered indicator/totalizer and with batch controller)
	3	“Confirm” key: <ul style="list-style-type: none"> • to confirm the function displayed • to confirm the parameters set
	4	<ul style="list-style-type: none"> • For Inline flowmeter with a standard output signal <ul style="list-style-type: none"> – status LED of relay 2 • For batch controller <ul style="list-style-type: none"> – status LED of relay DO3 (LED ON = contact closed)
	5	<ul style="list-style-type: none"> • For Inline flowmeter with a standard output signal <ul style="list-style-type: none"> – status LED of relay 1 • For batch controller <ul style="list-style-type: none"> – status LED of relay DO2 (LED ON = contact closed)
	6	Status of device <ul style="list-style-type: none"> • No status for Inline flowmeter with a standard output signal • For Inline flowmeter as a battery powered indicator/totalizer <ul style="list-style-type: none"> – off: the device operates correctly. – blinking orange: a warning message is generated in the information menu. – blinking red: a fault message is generated • For batch controller <ul style="list-style-type: none"> – green: the device operates correctly. – orange: a dosing related alarm and/or a warning messages is generated in the information menu. – red: a fault message is generated in the information menu.. – blinking, whatever the colour: <ul style="list-style-type: none"> - slow blinking: the dosing is interrupted. - Fast blinking during a dosing: a dosing related alarm is generated. - Fast blinking when no dosing is being done: the information menu has been remote-consulted or a check for the correct behaviour of the inputs/outputs is running

The device can be calibrated by means of the K-factor of the fitting used, or via the Teach-In function. User adjustments, such as engineering units, output, filter, bargraph are carried out on site.

Inline flowmeter with a standard output signal

The device has 2 operating levels:

- the process level
- the configuration level, which comprises the parameters and the test menus

Operating level	Functions
Process	<ul style="list-style-type: none"> • Indication of <ul style="list-style-type: none"> – the value of the measured flow – the value of the 4...20 mA output – the value of the main totalizer – the value of the daily totalizer • Reset the daily totalizer • Access to the Parameters and Test menus of the Configuration level
Configuration - parameters menu	<ul style="list-style-type: none"> • To make the settings needed for operation: <ul style="list-style-type: none"> – language – engineering units (International measuring units) – K-factor/Teach-In function – 4...20-mA-current output – pulse output – relay (on devices with relays) – filter (damping) – reset both totalizers
Configuration - test menu	<ul style="list-style-type: none"> • To adjust the Offset and Span of the 4...20 mA current output • To read the rotational frequency of the paddle wheel • To check the correct operating of the outputs with simulating a flow rate

Inline flowmeter as battery powered indicator/totalizer

The device has 2 operating levels:

- the process level
- the configuration level, which comprises the parameters, the test and the information menus

Operating level	Functions
Process	<ul style="list-style-type: none"> • Indication of <ul style="list-style-type: none"> – the value of the measured flow – the value of the main totalizer – the value of the daily totalizer • Reset the daily totalizer • Access to the Parameters, Test and Information menus of the Configuration level
Configuration - parameters menu	<ul style="list-style-type: none"> • To make the settings needed for operation: <ul style="list-style-type: none"> – language – engineering units (International measuring units) – K-factor/Teach-In function – filter (damping) – reset both totalizers
Configuration - test menu	<ul style="list-style-type: none"> • To read the rotational frequency of the paddle wheel • To generate warning and error messages
Configuration - information menu	<ul style="list-style-type: none"> • To read <ul style="list-style-type: none"> – the charge of the batteries – the error or warning messages generated by the device

Batch controller

The device has 2 operating levels:

- The process level
- The configuration level, which includes the parameters, the test, the information and the history menus

Operating level	Functions
Process	<ul style="list-style-type: none"> • Starting a dosing • Indication of <ul style="list-style-type: none"> – The value of the main totalizers of the quantity of fluid counted – The value of the daily totalizers of the quantity of fluid counted – The value of the main totalizers of the performed dosings – The value of the daily totalizers of the performed dosings • Reset <ul style="list-style-type: none"> – The daily volume or mass totalizer – The daily totalizer of the performed dosings • Access to the parameters, test, information and history menus of the configuration level
Configuration - parameters menu	<ul style="list-style-type: none"> • To make the settings needed for operation: <ul style="list-style-type: none"> – language – engineering units (International measuring units) – K-factor/Teach-In function – Optional/dosing mode – Overfill – Alarm – Outputs – Resetting the 2 volume or mass totalizers – Resetting the 2 totalizers of the performed dosings – Resetting the history menu – Backlight
Configuration - test menu	<ul style="list-style-type: none"> • Checking: <ul style="list-style-type: none"> – The inputs functions – The outputs functions – The paddle-wheel operation • Monitoring: <ul style="list-style-type: none"> – The flow rate in the pipe – The value of the daily volume or mass totalizer – The number of performed dosings • Saving/ Restoring: <ul style="list-style-type: none"> – The current user configuration – The saved configuration – The default configuration of the device
Configuration - history menu	To consult the quantities dosed in the last 10 dosings performed
Configuration - information menu	To read the fault and warning messages generated

8.3. Function modes

Inline flowmeter with a standard output signal

- 4...20 mA output + Pulse
- 4...20 mA output + Pulse + relay output
Hysteresis switching mode (both relays) for the output, inverted or not

Hysteresis mode

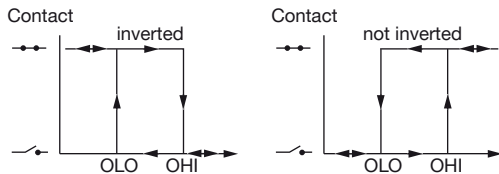

Batch controller

The following dosing modes are possible:

- **Locally started dosing of free quantity:** the user enters the quantity to be filled and starts the dosing from the keypad.
- **Locally started dosing of pre-set quantity:** the user selects a quantity which has been pre-set and starts the dosing from the keypad.
- **Locally started dosing of free/pre-set quantity:** the user enters the quantity to be filled or selects a quantity which has been pre-set and starts the dosing from the keypad.
- **Dosing controlled by a PLC unit:** the user selects a quantity which has been pre-set and starts the dosing using binary inputs.
- **Locally/remote selection of pre-set quantity and dosing controlled by a PLC unit:** the user selects a quantity which has been pre-set from the keypad or using binary inputs and starts the dosing using binary inputs.
- **Automatic dosing controlled by variation of pulse duration:** the quantity of the dosing is directly proportional to the duration of a pulse.
- **Remote dosing determined by Teach-In:** Teach-In of the dosing quantity using binary inputs.
- **Local dosing determined by Teach-In:** Teach-In of the dosing quantity from the keypads.

9. Product design and assembly

9.1. Product assembly

Note:

- The 8035 device is made up of a compact Inline sensor-fitting (S030) equipped with a sensor with paddle wheel and a transmitter (SE35).
The electronic housing of the 8035 integrates the electronic board with display, setting parameter keys and also a transducer (coil for battery indicator/totalizer version or Hall for other versions).
- The S030 Inline sensor-fitting ensures simple installation into pipes from DN 06...DN 65. The SE35 transmitter can easily be installed into any Bürkert sensor-fitting system, by means of a quarter turn.

See **data sheet Type S030** ▶ for more information.

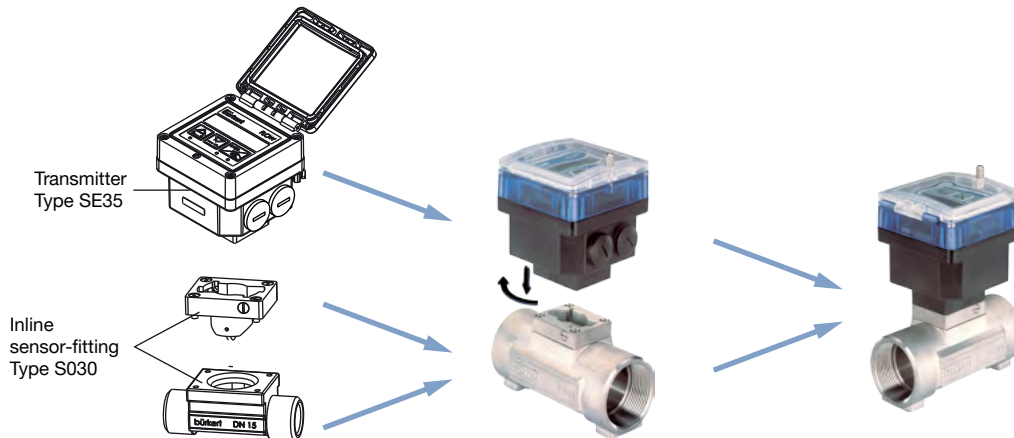

10. Networking and combination with other Bürkert products

10.1. Inline flowmeter with a standard output signal

Example:

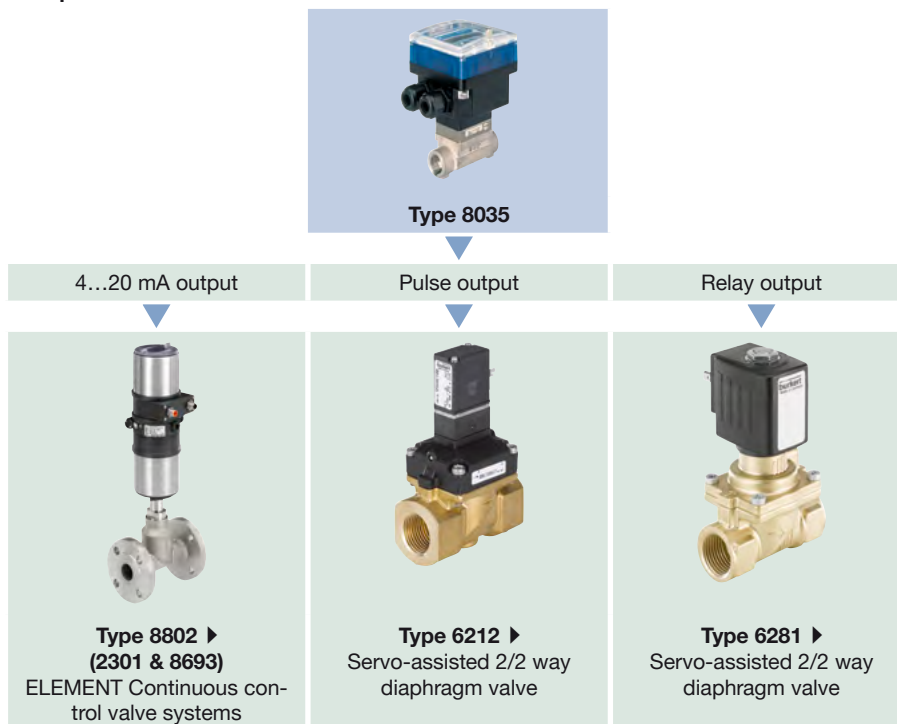

10.2. Batch controller

Example:



11. Ordering information

11.1. Bürkert eShop – Easy ordering and quick delivery



Bürkert eShop – Easy ordering and fast delivery

You want to find your desired Bürkert product or spare part quickly and order directly? Our online shop is available for you 24/7. Sign up and enjoy all the benefits.

[Order online now](#)

11.2. Recommendation regarding product selection

A complete 8035 Inline flowmeter or batch controller consists of a compact SE35 flow transmitter and a Bürkert S030 Inline sensor-fitting.

See [data sheet Type S030 ▶](#) for more information.

Two different components must be ordered in order to select a complete device. The following information is required:

- **Article no.** of the desired compact SE35 flow transmitter (see chapter [“11.4. Ordering chart” on page 22](#))
- **Article no.** of the selected S030 Inline sensor-fitting (See [data sheet Type S030 ▶](#))

11.3. Bürkert product filter











Bürkert product filter – Get quickly to the right product

You want to select products comfortably based on your technical requirements? Use the Bürkert product filter and find suitable articles for your application quickly and easily.

[Try out our product filter](#)

11.4. Ordering chart



Inline flowmeter

Voltage supply	Output	Relays	Sensor version	UL certification	Electrical connection	Article no.
Standard output signal version Type SE35, 2 totalizers						
12...36 V DC	4...20 mA (2 wires) + Pulse	None	Hall	—	Female cable plug EN 175301-803	444005 
				UL-Recognized		570477 
				—	2 cable glands	444006 
				UL-Recognized	2 cable glands	553432 
	4...20 mA (3 wires) + Pulse	2	Hall	—	2 cable glands	444007 
				UL-Recognized	2 cable glands	553433 
115/230 V AC	4...20 mA (2 wires) + Pulse	None	Hall	—	2 cable glands	423922 
	4...20 mA (3 wires) + Pulse	2	Hall	—	2 cable glands	423924 
Battery powered indicator/totalizer version Type SE35, 2 totalizers						
4 × 1.5 V DC AA batteries	None	None	Coil	—	None	423921 







Batch controller

All these versions have as minimum:

- 2 transistor outputs (DO1 and DO4)
- 2 relay outputs (DO2 and DO3)
- 4 digital inputs (DI1...DI4)
- 2 volume or mass totalizers
- 2 batch totalizers

Voltage supply	Sensor version	UL certification	Electrical connection	Article no.
12...36 V DC	Hall	—	2 cable glands	443360 
		UL-Recognized		564398 
115/230 V AC		—		423926 

11.5. Ordering chart accessories

Description	Article no.
For Inline flowmeter or batch controller	
Set with 2 cable glands M20 × 1.5 + 2 neoprene flat seals for cable gland or plug + 2 screw plugs M20 × 1.5 + 2 multiway seals 2 × 6 mm	449755 
Set with 2 reductions M20 × 1.5 /NPT ½" + 2 neoprene flat seals for cable gland or plug + 2 screw plugs M20 × 1.5	551782 
Set with 1 stopper for unused cable gland M20 × 1.5 + 1 multiway seal 2 × 6 mm for cable gland + 1 black EPDM seal for the sensor + 1 mounting instruction sheet	551775 
For Inline flowmeter	
Female cable plug EN 175301-803 with cable gland - see Type 2518 ▶	572264 
Female cable plug EN 175301-803 with NPT ½" reduction without cable gland - see Type 2509 ▶	162673 
For batch controller	
Set with 8 FLOW front panel foils	553191 

Bürkert – Close to You

For up-to-date addresses
please visit us at
www.burkert.com

DTS 1000011089 EN Version: S Status: RL (released | freigegeben | validé) printed: 09.02.2022

